

**PHILIPS**

*DreamStation 2*

CPAP Advanced

Auto CPAP Advanced

User manual

**Regional**  
HOME CARE





## Contents

1. Safety information .....	1
Intended use .....	1
Important .....	1
Contraindications .....	1
Warnings .....	2
Cautions .....	5
Symbols glossary .....	8
System contents .....	9
How to contact Philips Respironics .....	9
2. System overview .....	10
Device with integrated humidifier .....	10
Humidifier water tank .....	12
3. Device setup .....	14
Where to place the device .....	14
Supplying AC power to the device .....	14
Setting up the integrated humidifier .....	16
Installing/replacing the air filters .....	20
Connecting the breathing circuit .....	22
Starting the device .....	24
Performance check .....	25
Bluetooth wireless technology .....	25
Pairing your therapy device to your Bluetooth-enabled mobile device .....	25
Therapy On display .....	26
Therapy Off display .....	30
Navigating the settings screens .....	32
Settings screens .....	33
Modem call .....	35
4. Pop-up messages and troubleshooting .....	37
Pop-up messages .....	37
Status pop-up messages .....	39
Reminder pop-up messages .....	40
Troubleshooting .....	41
5. Connectivity .....	43
6. Accessories .....	44
SD card .....	44
Oximeter .....	45
Roll stand .....	45
Supplemental oxygen .....	46
DC power .....	47
Carrying case and airline travel .....	47

7. Cleaning and care.....	48
Home cleaning: device exterior, heater plate, and humidifier air inlet seal .....	48
Home cleaning: humidifier water tank (lid, water tank base, and water tank seal) .....	48
Home cleaning: tubing .....	50
Caring for the filters.....	50
Service.....	51
8. Technical specifications .....	51
Environmental .....	51
Physical.....	51
Service life.....	51
Standards compliance .....	52
IEC 60601-1 classification .....	52
Electrical.....	52
Water capacity.....	52
Heater plate.....	53
Humidity .....	53
Declared dual-number noise emissions values (in accordance with ISO 4871) .....	53
Pressure accuracy.....	53
Maximum flow rate (typical).....	54
ISO 80601-2-70 Pneumatic Diagram .....	54
Wireless notices.....	55
Radio Specifications.....	56
Intake Port Filters.....	57
Heated Tubing Specifications.....	57
Disposal .....	57
9. EMC information.....	57
Limited Warranty .....	62

# 1. Safety information

## Intended use

The DreamStation 2 CPAP/DreamStation 2 Auto CPAP system delivers positive airway pressure therapy for the treatment of Obstructive Sleep Apnea in spontaneously breathing patients weighing over 30 kg (66 lbs). It is for use in the home or hospital/institutional environment.

## Important

The device is to be used only on the instruction of a licensed physician. Your home care provider will set the correct pressure settings and will provide accessories according to your health care professional's prescription.

Several accessories are available to make your OSA treatment with the DreamStation 2 system as convenient and comfortable as possible. To ensure that you receive the safe, effective therapy prescribed for you, use only Philips Respironics approved accessories.

## Contraindications

When assessing the relative risks and benefits of using this equipment, the clinician should understand that this device can deliver pressures up to 20 cmH<sub>2</sub>O. In the event of certain fault conditions, a maximum pressure of 40 cmH<sub>2</sub>O is possible. Studies have shown that the following pre-existing conditions may contraindicate the use of CPAP therapy for some patients:

- Bullous Lung Disease
- Pathologically Low Blood Pressure
- Bypassed Upper Airway
- Pneumothorax
- Pneumocephalus has been reported in a patient using nasal Continuous Positive Airway Pressure. Caution should be used when prescribing CPAP for susceptible patients such as those with: cerebral spinal fluid (CSF) leaks, abnormalities of the cribriform plate, prior history of head trauma, and/or pneumocephalus. (Chest 1989; 96:1425-1426)

The use of positive airway pressure therapy may be temporarily contraindicated if you exhibit signs of a sinus or middle ear infection. Not for use with patients whose upper airways are bypassed. Contact your health care professional if you have any questions concerning your therapy.



## Warnings

A warning indicates the possibility of injury to the user or operator.

<b>Device usage</b>	This device is not intended for life support.
	Contact your health care professional if symptoms of sleep apnea recur.
<b>Personnel qualifications</b>	This manual serves as a reference. The instructions in this manual are not intended to supersede your health care professional's instructions regarding the use of the device.
	The prescription and other device settings should only be changed on the order of the supervising physician.
	The operator should read and understand this entire manual before using the device.
<b>Operating temperature</b>	Do not operate the device in direct sunlight or near a heating appliance because these conditions can increase the temperature of the air coming out of the device.
<b>Bacteria filter</b>	If the device is used by multiple persons in a hospital environment (such as rental devices), a low-resistance, main flow bacteria filter should be installed in-line between the device and the circuit tubing to prevent contamination.
	Humidification can increase the resistance of the bacteria filter and the operator must monitor the bacteria filter frequently for increased resistance and blockage to ensure the delivery of the therapeutic pressure.
<b>Improperly functioning device</b>	If you notice any unexplained changes in the performance of the device, if it is making unusual sounds, if it has been dropped or mishandled, if water is spilled into the enclosure, or if the enclosure is cracked or broken, discontinue use and contact your home care service provider.
<b>Power cord</b>	Route the power cord to the outlet in a way that will prevent the cord from being tripped over or interfered with by chairs or other furniture.
	To avoid strangulation hazards, ensure that all cords connected to the device are properly routed.
	This device is activated when the power cord is connected.
	Use only power cords supplied by Philips Respironics for this device. Use of power cords not supplied by Philips Respironics may cause overheating or damage to the device.

<b>Patient circuits and tubing</b>	<p>The device should only be used with compatible patient interfaces (e.g., masks, circuits and exhalation ports). Proper operation of the device with other circuits has not been verified by Philips Respironics and is the responsibility of the health care professional. A mask should not be used unless the device is turned on and operating properly. The exhalation port(s) associated with the mask should never be blocked.</p> <p>Explanation of warning: The device is intended to be used with special masks or connectors that have exhalation ports to allow continuous flow of air out of the mask. When the device is turned on and functioning properly, new air from the device flushes the exhaled air out through the mask exhalation port. However, when the device is not operating, enough fresh air will not be provided through the mask, and exhaled air may be rebreathed. Rebreathing of exhaled air can, in some circumstances, lead to suffocation.</p>
	<p>If you are using a full face mask (a mask covering both your mouth and your nose), the mask must be equipped with a safety (enainment) valve.</p>
	<p>An exhalation port is required. Do not block the exhalation port. This can reduce airflow and result in rebreathing of exhaled air.</p>
	<p>At low expiratory pressures, the flow through the exhalation port may be inadequate to clear all exhaled gas from the tubing – some rebreathing may occur.</p>
	<p>Do not pull or stretch the tubing. This could result in circuit leaks.</p>
	<p>Do not cover the tubing with a blanket or heat it in an incubator or with an overhead heater. This can affect the quality of the therapy or injure the patient.</p>
	<p>The device should only be used with a compatible Philips Respironics mask, as prescribed by your Healthcare Provider.</p>
<b>Accessories</b>	<p>To ensure that you receive the safe, effective therapy prescribed for you, use only Philips Respironics accessories. The use of accessories, transducers, and cables other than those specified by Philips Respironics may result in increased emissions or decreased immunity of the device.</p>
<b>Pulse oximeter</b>	<p>Use only Philips Respironics recommended pulse oximeter and sensors. Use of incompatible sensors can result in inaccurate pulse oximeter performance.</p>
	<p>Do not use a damaged pulse oximeter or sensor.</p>
	<p>Before use, carefully read these instructions and the instructions for use provided with the pulse oximeter and sensor.</p>

Integrated humidifier	For safe operation when using the integrated humidifier, the device must always be positioned below the breathing circuit connection at the mask. The device must be level for proper operation.
	Allow the heater plate and water to cool down for approximately 15 minutes before removing the humidifier water tank. A burn may result from: touching the heater plate, coming in contact with the heated water, or touching the humidifier water tank pan.
Cleaning	To avoid electrical shock, always unplug the power cord from the wall outlet before cleaning the device.
	Do not immerse the device in any fluids or spray the device with water or cleaners. Clean the device with a cloth dampened with an approved cleaner.
	Empty and clean the humidifier water tank daily to prevent mold and bacteria growth.
Oxygen	When using oxygen with this system, the oxygen supply must comply with local regulations for medical oxygen.
	Do not connect the device to an unregulated or high pressure oxygen source.
	When using oxygen with this system, a Philips Respironics pressure valve must be placed in-line with the patient circuit between the device and the oxygen source. The pressure valve helps to prevent the back flow of oxygen from the patient circuit into the device when the unit is off. Failure to use the pressure valve could result in a fire hazard.
	Oxygen supports combustion. Oxygen should not be used while smoking or in the presence of an open flame.
	Do not use the device in the presence of a flammable anaesthetic mixture in combination with oxygen or air, or in the presence of nitrous oxide..
	Do not use the device near a source of toxic or harmful vapors.
	When using oxygen with this system, turn the device on before turning on the oxygen. Turn the oxygen off before turning the device off. This will prevent oxygen accumulation in the device. <b>Explanation of the Warning:</b> When the device is not in operation and the oxygen flow is left on, oxygen delivered into the tubing may accumulate within the device's enclosure. Oxygen accumulated in the device enclosure will create a risk of fire.

EMC	Use of this equipment adjacent to or stacked with other equipment should be avoided because it could result in improper operation. If such use is necessary, this equipment and the other equipment should be observed to verify that they are operating normally
	Portable and Mobile RF Communications Equipment can affect Medical Electrical Equipment. See the EMC section of this manual for distances to observe between RF Generators and the ventilator to avoid interference.
	Do not use this device near active high frequency surgical equipment and the Radio Frequency shielded room of a Medical Electrical system for magnetic resonance imaging, where the intensity of electromagnetic disturbances is high.
	The Health Industry Manufacturers Association recommends that a minimum separation of six inches be maintained between a wireless phone and a pacemaker to avoid potential interference with the pacemaker. The DreamStation 2 on-board <i>Bluetooth</i> communication should be considered a wireless phone in this regard.
Maintenance	Never operate the device if any parts are damaged or if it is not working properly. Replace damaged parts before continuing use.
	Periodically inspect electrical cords, cables, tubing, and accessories for damage or signs of wear. Discontinue use and replace if damaged.
	Repairs and adjustments must be performed by Philips Respironics-authorized service personnel only. Unauthorized service could cause injury, invalidate the warranty, or result in costly device damage. Contact your home care service provider for maintenance.
	Do not use the device if the humidifier water tank is leaking or damaged. Replace any damaged parts before continuing use.



## Cautions

A caution indicates the possibility of damage to the device.

US federal  
law













Caution! US federal law restricts this device to use by or on the order of a physician







<b>Electrostatic Discharge (ESD)</b>	<p>Do not use antistatic or conductive hoses or conductive patient tubing with the device.</p> <p>Pins of connectors marked with the ESD warning symbol shall not be touched and connections shall not be made without special precautions. Precautionary procedures include methods to prevent build-up of electrostatic charge (e.g., air conditioning, humidification, conductive floor coverings, non-synthetic clothing), discharging one's body to the frame of the equipment or system or to earth. It is recommended that all individuals that will handle this device understand these precautionary procedures at a minimum as part of their training.</p>
<b>Condensation</b>	<p>Condensation may damage the device. If the device has been exposed to either very hot or very cold temperatures, allow it to adjust to room temperature (operating temperature) for 24 hours before starting therapy. Do not operate the device outside of the environmental operating ranges listed in the "Technical specifications" section later in this manual.</p>
<b>Filters</b>	<p>A properly installed, undamaged Philips Respironics reusable pollen filter is required for proper operation.</p> <p>Dirty inlet filters may cause high operating temperatures that may affect device performance. Regularly examine the inlet filters as needed for integrity and cleanliness.</p> <p>Never install a wet filter into the device. You must ensure sufficient drying time for the cleaned filter.</p> <p>Make sure the air inlet (slotted) area on the side of the device is not blocked by bedding, curtains, or other items. Air must flow freely around the device for the system to work properly.</p>
<b>Extension cords</b>	<p>Do not use extension cords with this device.</p>
<b>DC power</b>	<p>Always ensure that the DC power cord securely fits into your therapy device prior to use. Contact your home care service provider to determine if you have the appropriate DC cord for your specific therapy device.</p> <p>When DC power is obtained from a vehicle battery, the device should not be used while the vehicle's engine is running. Damage to the device may occur.</p> <p>Only use a Philips Respironics DC power cord and battery adapter cable. Use of any other system may cause damage to the device.</p>

<b>Tobacco use</b>	Tobacco smoke may cause tar build up within the device.
<b>Device placement</b>	Do not place the device in or on any container that can collect or hold water. Take precautions to protect furniture from water damage.
	Do not place the device directly onto carpet, fabric, or other flammable materials.
	Do not plug the device into an outlet controlled by a wall switch.
	Do not move the device while the humidifier water tank has water in it.
<b>Humidifier water tank</b>	Remove the humidifier water tank, empty all water, and replace the empty humidifier water tank before transporting the device.
	Do not fill the humidifier water tank above the maximum fill line. If the humidifier water tank is overfilled, water may leak into the therapy device, humidifier, or onto your furniture. Damage to the humidifier or therapy device may occur.
	Use only room temperature distilled water in the humidifier water tank. Do not put any chemicals or additives into the water. Possible airway irritation or damage to the humidifier water tank may result.
	If using the integrated humidifier, do not start therapy without the humidifier water tank installed.
	Do not attempt to fill the humidifier water tank while it is still connected to the device.
<b>Cleaning</b>	Do not immerse the device or allow any liquid to enter the enclosure or the inlet filter.
	Do not steam autoclave the device. Doing so will destroy the device.
	Do not use harsh detergents, abrasive cleaners, or brushes to clean the system.
	Only the cleaning procedures listed in this manual are recommended by Philips Respironics. Use of other cleaning processes, not specified by Philips Respironics, may affect the performance of the product.

## Symbols glossary

The following symbols may appear on the device, power supply, and accessories. For a full list and description of the symbols used on the device and its packaging, see [www.symbols.philips.com](http://www.symbols.philips.com).

Symbol	Title and Meaning	Symbol	Title and Meaning
	Consult instructions for use.		Type BF applied part To identify a type BF applied part complying with IEC 60601-1.
	Prescription device Caution: U.S. federal law restricts this device to sale by or on the order of a physician.		DC power (Direct current)
	For indoor use only Equipment is designed primarily for indoor use.	<b>IP22</b>	Drip proof equipment
	MR unsafe Do not use device in a Magnetic Resonance (MR) environment.		Approved for airline use.
	<i>Bluetooth</i> <sup>®</sup> symbol Indicates the device has <i>Bluetooth</i> capabilities.		Maximum fill line
	Unique Device Identifier Indicates the Unique Device Identifier information.		Warning: Hot surface
	AC power (Alternating current)		Packaging unit To indicate the number of pieces in the package.

Symbol	Title and Meaning	Symbol	Title and Meaning
	Caution, consult accompanying documents.		Class II equipment (Double Insulated) To identify equipment meeting the safety requirements specified for Class II equipment.
	Single patient use Indicates that the tubing is for single patient use only.		Do not disassemble.
	Importer Indicates the entity importing the medical device into the EU.		Keep away from sunlight Indicates the medical device needs protection from light sources.

## System contents

Your system may include the following items:

- Device
- Humidifier water tank
- User manual
- Quick start guide
- Carrying case
- SD Card
- Reusable filter
- Disposable ultra-fine filter (optional)
- Flexible Tubing
- 6 ft. (1.83 m) power cord
- Power supply

## How to contact Philips Respironics

Should you experience trouble with this equipment or require assistance setting up, using, or maintaining the device or accessories, please contact your home care provider. If you need to contact Philips Respironics directly, call the Philips Respironics Customer Service department at 1-800-345-6443 or 1-724-387-4000. You can also use the following address:

Respironics, Inc.  
1001 Murry Ridge Lane  
Murrysville, PA 15668

## 2. System overview

The DreamStation 2 CPAP Advanced/DreamStation 2 Auto CPAP Advanced is a Continuous Positive Airway Pressure therapy device designed for the treatment of Obstructive Sleep Apnea (OSA).

The integrated humidifier and optional heated tubing is designed to deliver humidification to provide added comfort during therapy. This humidification level is controlled through the output of the heated humidifier as well as the temperature of the optional heated tubing. Use of the integrated humidifier with the heated tubing allows for a comfortable level of humidity to be maintained at the mask.

Several accessories are also available for use with your device. Contact your home care provider to purchase any accessories not included with your system.

### Device with integrated humidifier

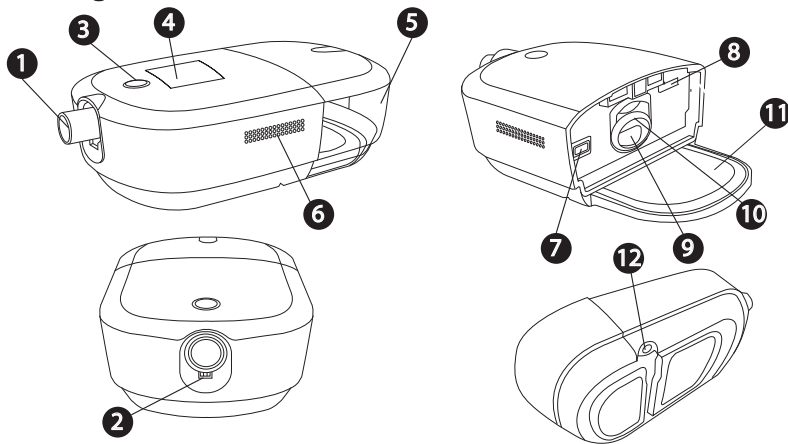

#	Feature	Description	#	Feature	Description
1	Air outlet port	Connect the flexible tubing here	7	Filter access	Access the filter here.
2	Heated tubing pin connector	Line up and connect the heated tubing connector here	8	SD card access	Access the SD card here.
3	Therapy on/off button	Starts and stops the airflow for therapy.	9	Air inlet for the humidifier	Connects to the humidifier water tank
4	Display screen	This is the User Interface for the therapy device.	10	Humidifier air inlet/outlet seal	Provides a seal between the device and the humidifier water tank.
5	Humidifier water tank	Removable water tank that holds the water for humidification (shown installed)	11	Heater plate	Warms the water in the water tank
6	Air inlet	Delivers air to the device	12	Power inlet	Connect the power cord here

## Humidifier water tank

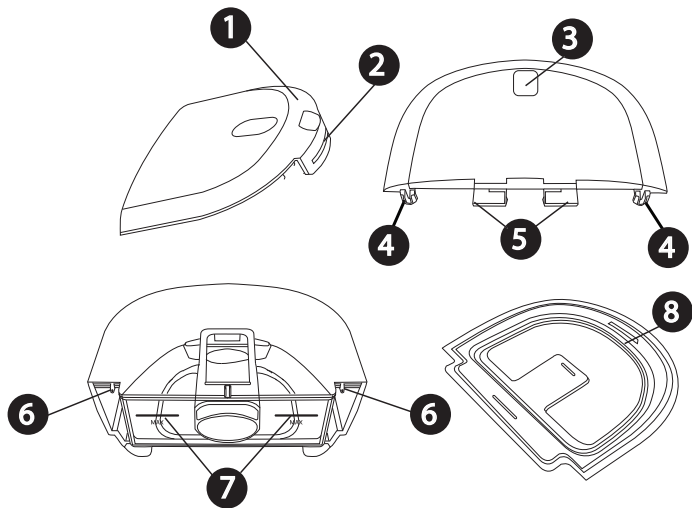

#	Feature	Description
1	Lid	Removable to fill the water tank.
2	Lid front tab	Remove lid from here
3	Water tank release indent	Unlatches water tank from the device when pressed
4	Lid hooks	Connect over water tank base tabs
5	Water tank latch	Latches the water tank to the device
6	Water tank base tabs	Connect water tank lid hooks here to attach the water tank lid
7	Maximum fill lines	Indicate the maximum water level for safe operation. The fill lines also appear on the sides of the water tank base.
8	Water tank seal	Provides a seal between the water tank lid and base. Removable for ease of cleaning.
9	Grip indent (not shown)	Grip indent, located on the bottom of the water tank base, for tank removal

### 3. Device setup

#### Where to place the device

Place the device on a firm, flat surface somewhere within easy reach of where you will use it at a level lower than your sleeping position. Make sure the device is away from any heating or cooling equipment (e.g., forced air vents, radiators, air conditioners).

**Note:** When positioning the device, make sure that the power cable is accessible because removing power is the only way to turn off the device.

#### Cautions

- Make sure the air inlet (slotted) area on the side of the device is not blocked by bedding, curtains, or other items. Air must flow freely around the device for the system to work properly.
- Do not place the device directly onto carpet, fabric, or other flammable materials.
- Do not place the device in or on any container that can collect or hold water.

#### Supplying AC power to the device

**Warning:** Periodically inspect electrical cords and cables for damage or signs of wear. Discontinue use and replace if damaged.

**Caution:** Do not use extension cords with this device.

Complete the following steps to operate the device using AC power and refer to the following images for guidance:

1. Ensure that the humidifier tank is empty.
2. Plug the power supply cord's connector into the power inlet on the bottom of the device **1** or **2**.

For convenience, the power connection allows for the cord to connect and route in the direction that works best for your setup.

An inset area on the bottom of the device allows the cord to be routed under the device **3**.

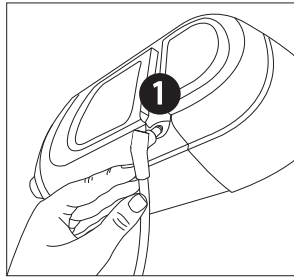

OR

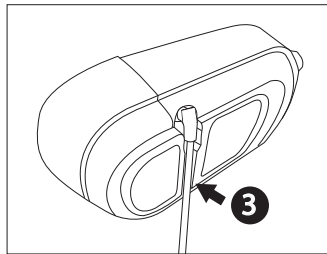
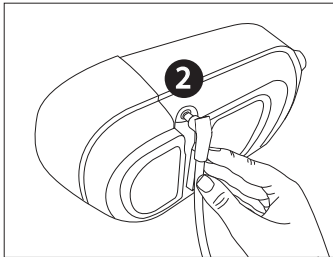

3. Plug the socket end of the AC power cord into the power supply ④.
4. Plug the pronged end of the AC power cord into an electrical outlet that is not controlled by a wall switch ⑤.
5. Verify that the connections on the bottom of the device, at the power supply, and at the electrical outlet are fully inserted. This will help to ensure that a secure, reliable electrical connection has been made.

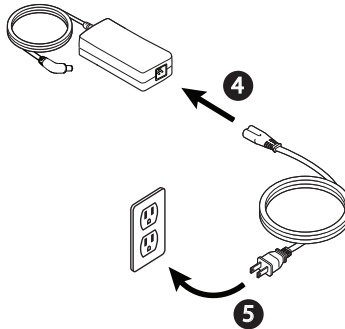

**Important:** To remove AC power, disconnect the power supply cord from the electrical outlet.

## Setting up the integrated humidifier

**Warning:** Allow the heater plate and water to cool down for approximately 15 minutes before removing the water tank. A burn may result from: touching the heater plate, coming in contact with the heated water, or touching the tank pan.

### Cautions

- Do not attempt to fill the humidifier water tank while it is still attached to the device.
- Use only room temperature distilled water in the tank. Do not put any chemicals or additives into the water. Possible airway irritation or damage to the water tank may result.
- Do not fill the humidifier water tank above the maximum fill line. If the humidifier water tank is overfilled, water may leak into the therapy device, humidifier, or onto your furniture. Damage to the therapy device may occur.

**Note:** Clean the humidifier water tank before first use. Refer to the “Home cleaning: humidifier water tank” section in this manual.

## Removing the humidifier water tank

1. Gently press down on the indented area on the top of the humidifier water tank to unlatch the tank from the device.

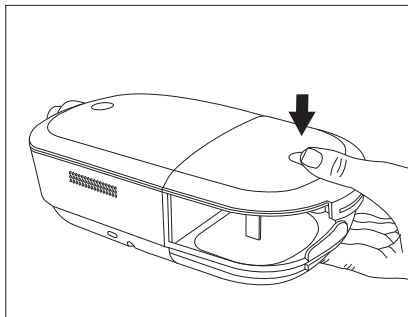

2. Grip the top and bottom of the humidifier water tank and slide it out away from the device.

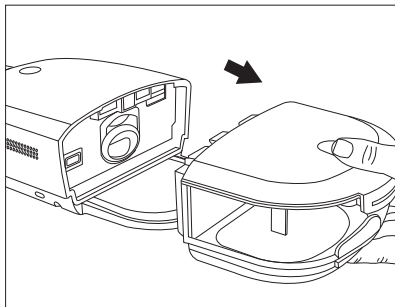

3. Remove the lid by pulling up on the lid tab while holding the water tank base.

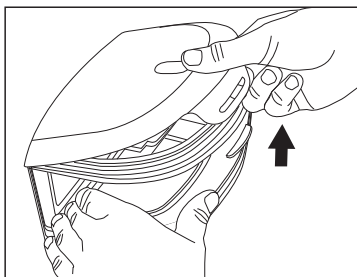
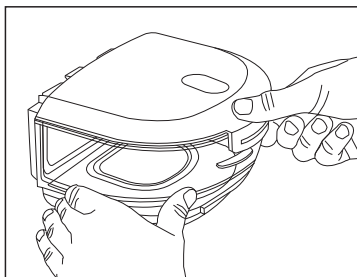

4. Pour out any remaining water and rinse the water tank base.

#### Filling and connecting the water tank

1. Place the water tank base on a firm, flat surface. Fill the water tank with distilled water no higher than the maximum fill lines  $\overline{\text{MAX}}$ , which are located on the back and sides of the water tank base.

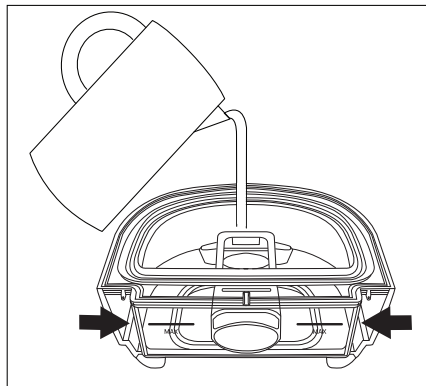

2. Reattach the lid. Place the hooks on the lid **1** over the small tabs on the water tank base **2**.

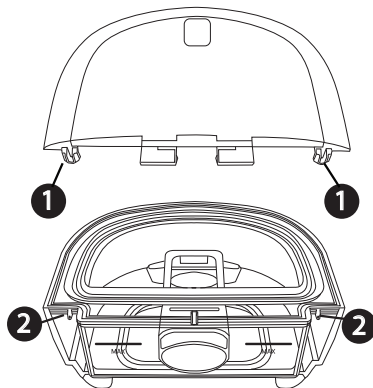

3. Press down **3** until the lid snaps securely over the lid front tab **4** on the front of the water tank base.

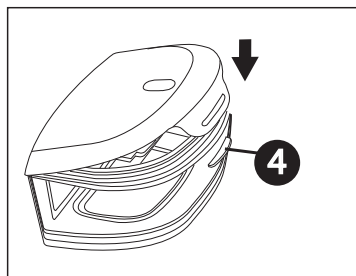
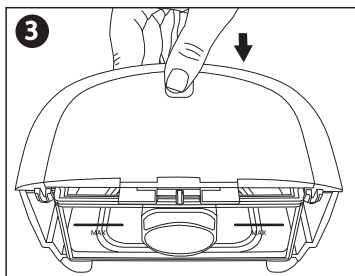

4. Slide the humidifier water tank back into the device, using the tracks on the bottom of the water tank base for proper alignment and connection. Ensure that it is latched into place before proceeding.

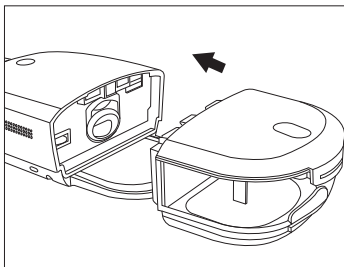

### **Installing/replacing the air filters**

**Caution: A properly installed, undamaged Philips Respironics reusable pollen filter is required for proper operation.**

The device uses a grey reusable pollen filter that can be rinsed and a blue disposable ultra-fine filter. The reusable filter screens out normal household dust and pollens, while the ultra-fine filter provides more complete filtration of very fine particles. The reusable filter must be in place at all times when the device is operating. The ultra-fine filter is recommended for people who are sensitive to tobacco smoke or other small particles.

The grey reusable filter is supplied with the device. A disposable blue ultra-fine filter may also be included. If a filter is not installed when you receive your device, you must at least install the reusable filter before using the device.

1. Remove the humidifier water tank from the device. See the “Removing the humidifier water tank” section later in this manual.

2. To remove an existing filter, pull the white tab on the end of the filter and pull the filter out of the device

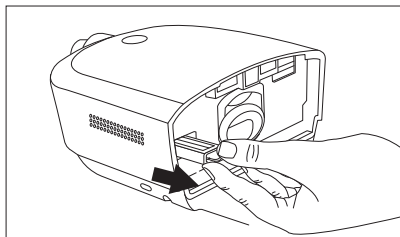

3. If applicable, place a dry, grey reusable pollen filter on top of a new, optional blue disposable ultra-fine filter, align the arrows on both filters, and firmly snap them together.
4. Place the filter into the therapy device.

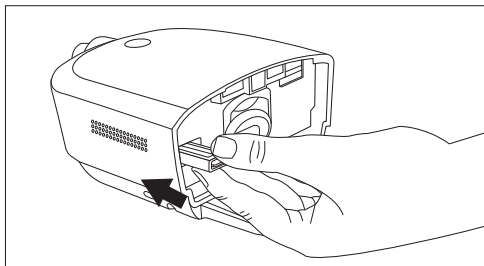

5. Reinstall the humidifier water tank.

## Connecting the breathing circuit

To use the system, you will need the following accessories in order to assemble the recommended breathing circuit:

- Philips Respironics interface (nasal mask or full face mask) with integrated exhalation port, or Philips Respironics interface with a separate exhalation device (such as the Whisper Swivel II)
- Philips Respironics flexible tubing (12, 15, or 22 mm standard tubing or 12 or 15 mm heated tubing), 1.83 m (6 ft.)
- Philips Respironics headgear (for the mask)

### Warnings

- **Do not pull or stretch the tubing. This could result in circuit leaks.**
- **Inspect the tubing for damage or wear. Discard and replace the tubing as necessary.**
- **If you are using a full face mask (a mask covering both your mouth and your nose), the mask must be equipped with a safety (entrainment) valve.**
- **If the device is used by multiple persons (such as rental devices), a low-resistance, main flow bacteria filter should be installed in-line between the device and the circuit tubing to prevent contamination.**

To connect your breathing circuit to the device, complete the following steps.

**Note:** If you are using the optional 12 mm (non-heated) performance tubing, an adapter is required to connect to the therapy device.

**Note:** Tubing is identified on the cuff with the tubing identifier symbol: “12”, “15”, “HT12”, or “HT15”. 22 mm tubing contains no symbol.

1. To connect heated tubing (shown), line up the pin connectors on the heated tube with the bottom of the air outlet port on the device. The clips at the end of the tubing should be aligned to the sides of the port and will click into place.

If you are using standard tubing (not shown), simply slide the tubing over the air outlet port on the device.

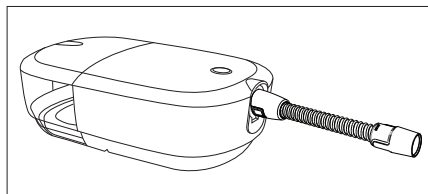
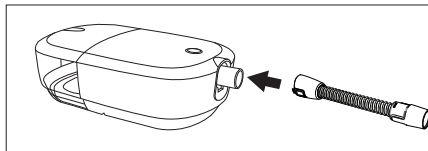

2. If you are using the optional 12 mm heated tubing or 12 mm performance tubing, connect the provided mask adapter to the mask connection end of the tubing. The 12mm performance tubing also requires a device adapter. When connecting the adapter to the CPAP, the clips should be aligned to the sides with the slight bump facing straight down.

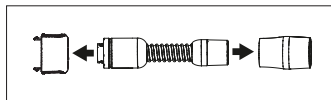

3. Connect the tubing to the mask. For proper placement and positioning, refer to the instructions that came with your mask.
4. Attach the headgear to the mask if necessary. Refer to the instructions that came with your headgear.

## Starting the device

1. Ensure power is supplied to the device as indicated by a white ring around the therapy button. The first screen to display will be the Philips logo, followed by the device model screen, and then a screen that contains a summary of your therapy. See the “Therapy off display” section later in this manual for a description of the User Interface (UI) screens.  
**Note:** The device may prompt you to set the language and time. These settings can always be adjusted from the device settings screen.
2. Put on your mask assembly. Refer to the instructions supplied with the mask.  
A small amount of mask leak is normal and acceptable. Correct large amount of mask leaks or eye irritation by adjusting your mask headgear.  
**Note:** If you are using the device in a bed with a headboard, try placing the tubing over the headboard. This may reduce tension on the mask.
3. Press the Therapy button on top of the device to turn on airflow and begin therapy. The Therapy button ring will illuminate blue.  
**Note:** If your home care provider has enabled the Automatic On feature, the device will automatically turn the airflow on when you put on your mask and breathe.

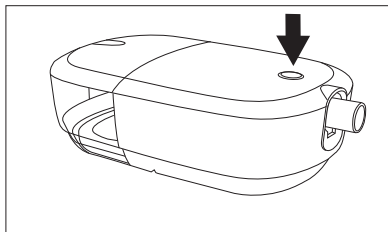

4. Press the Therapy button again to turn off the therapy. The Therapy button ring will illuminate white.  
**Note:** If your home care provider has enabled the Automatic Off feature, the device will automatically turn the airflow off when you take off your mask and the device recognizes inactivity.

## Performance check

To initiate a performance check, unplug the device and plug it back in. An error will appear on the screen if a performance issue is detected.

## Bluetooth wireless technology

Bluetooth wireless technology is one method by which you can transfer your therapy device's data to DreamMapper. DreamMapper is a mobile system designed to help Obstructive Sleep Apnea (OSA) patients enhance their sleep therapy experience.

### Pairing your therapy device to your Bluetooth-enabled mobile device

**Note:** The blower must be off to allow Bluetooth pairing.

**Note:** You can only pair your therapy device to one mobile device at any given time.

**Note:** Pairing works best when your therapy device and mobile device are in the same room.

**Note:** The current version of DreamMapper will guide you through these instructions.

**Note:** After initiating pairing in DreamMapper, you will have 30 seconds to complete the setup. After this time, it will be cancelled automatically.

Follow the steps below to manually pair to your mobile phone or tablet.

1. With your therapy device powered up, initiate Bluetooth Setup from the DreamMapper mobile app.  
**Note:** From DreamMapper you may need to select from a list of available Bluetooth devices. The therapy device will appear as "PR BT XXXX" (XXXX will be the last four digits of the serial number listed on your therapy device).
2. The pairing code will display on the device.
3. In DreamMapper, confirm the 6-digit pairing code displayed on the therapy device.  
**Note:** When pairing from certain mobile devices you may need to enter the 6-digit pairing code in DreamMapper. Once entered, pairing will automatically begin.
4. Tap "Pair" to complete pairing. The therapy device displays "Pairing to Device" and then "Success Bluetooth Device is now Paired".

## Therapy On display

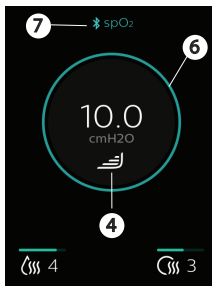
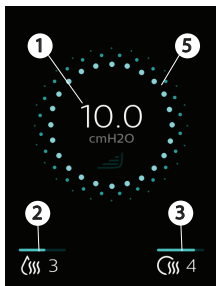

The UI on this device allows you to adjust the device settings and view information about your therapy. The UI consists of the display screen with touch capability.

While the device is delivering therapy, the pressure setting is displayed. You can also view and adjust humidification, heated tube temperature, and RAMP PLUS settings.



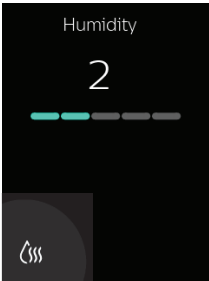

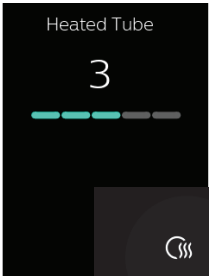

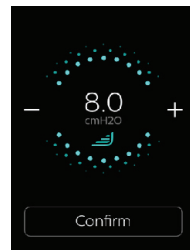

#	Symbol	Feature	Description
1	cmH2O	Therapy pressure	Displays the prescription pressure setting. If RAMP PLUS is running, the current delivered pressure is displayed.

#	Symbol	Feature	Description
2		Adjustable humidifier setting (if available)	<p>The icon only displays when humidification is enabled by your home care provider. To change the setting, tap the humidification icon. A settings screen displays your current setting.</p> <div data-bbox="640 256 847 538" data-label="Image">  </div> <p>Continue to tap the humidification icon until the desired setting is displayed. The available settings are Off or 1-5, with 1 as the lowest humidity and 5 as the highest humidity. Once humidification is set, the device will return to the therapy screen after a few seconds and automatically activate the new setting for current and future therapy settings.</p>

#	Symbol	Feature	Description
3		Heated tube temperature (if available)	<p>The icon only displays if enabled by your home care provider when a heated tube is being used. To change the setting, tap the heated tube icon. A settings screen displays your current setting.</p> <div data-bbox="640 256 847 533" data-label="Image">  </div> <p>Continue to tap the heated tube icon until the desired setting is displayed. The available settings are Off or 1-5, with 1 as the lowest temperature and 5 as the highest temperature. Once a temperature is set, the device will return to the therapy screen after a few seconds and automatically activate the new setting for current and future therapy settings.</p>
4		RAMP PLUS (Ramp+)	<p>The device is equipped with a RAMP PLUS feature that allows you to adjust your starting pressure for a set period of time (default of 30 minutes) for added comfort when you are trying to fall asleep. During that set time, the air pressure will remain at your set starting pressure unless the device detects an event and identifies the need to increase your pressure. When RAMP PLUS has concluded, your prescribed therapy pressure will resume.</p> <p>To activate the RAMP PLUS setting, tap . Tapping will also simultaneously allow you to adjust the settings.</p>

#	Symbol	Feature	Description
4		RAMP PLUS (Ramp+)	<p>The first time RAMP PLUS is activated, the setting will default to 4. To change the setting, tap the - or + icons until the desired starting pressure is displayed. For faster scrolling, hold the - or + icon instead of tapping.</p> <p>The RAMP PLUS pressures range from 4 cmH<sub>2</sub>O to 10 cmH<sub>2</sub>O in 1 cmH<sub>2</sub>O increments. Tap confirm or wait 3 seconds to save your setting. The display will then return to the therapy screen. Every therapy session thereafter will automatically start RAMP PLUS with the start of therapy.</p> <p>Note: There is no need to tap the RAMP PLUS symbol again unless you want to make a change to the RAMP PLUS pressure or restart RAMP PLUS.</p> <p>Note: RAMP PLUS pressure and time can also be adjusted in the Settings Menu on your main screen if enabled by your home care provider.</p> <p>Note: The device goes dark after 60 seconds of inactivity. To wake up the device, tap anywhere on the display. This will simultaneously reactivate your RAMP PLUS pressure (if set), or it will take you to your prescribed minimum pressure level and continue to automatically adjust your delivered pressure as needed (if in Auto CPAP mode). Once the display appears, you can continue to adjust settings as desired.</p>
5 and 6	N/A	Ramp indicator	<p>The therapy on display indicates when ramp is active. The circle around the therapy display is dotted blue (5) when ramp is active and solid blue (6) when ramp is not active or therapy pressure is achieved.</p>



#	Symbol	Feature	Description
7		Oximetry connection	This symbol displays during therapy when a pulse oximeter is connected to the therapy device.
Not shown		Therapy button ring	The therapy button ring illuminates blue to indicate therapy is turned on. The ring does not illuminate when therapy is on and the screen has gone dark. The ring illuminates white when the device is plugged in and therapy is off.
Not shown		Cell modem signal strength	Displays signal strength of cellular modem on devices that have the cellular modem available except when in Airplane Mode.
Not shown		Bluetooth	Displays when the device has Bluetooth available. When the symbol is grey, it indicates that Bluetooth is available. If the device is connected to a Bluetooth client (phone, tablet, etc.) it will appear white. This symbol does not appear when Airplane Mode is enabled.
Not shown		Airplane mode	Displays when Airplane Mode is enabled. It will replace the Cell and/or Bluetooth symbols when active.

## Therapy Off display

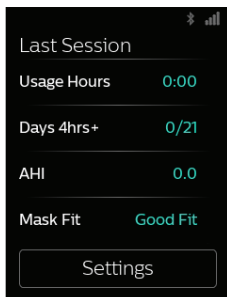

A summary of your therapy displays on the UI when therapy is turned off. You can view additional details about your therapy or perform a mask fit check. From here you can tap “Settings” to adjust Comfort and Device settings if enabled by your provider.

The following therapy results may appear on the Last Session screen. Tapping on the data displayed in blue text will give more history and detail for each item.

Text	Description
Usage hours	Displays an overview of your last day/night of usage in hours and minutes. Tapping the hours displayed in blue text shows your nightly usage for the last 3 sleep sessions.
Days 4hrs+	Displays the total number of 4+ hour nights that you have slept in the last 30 days. It provides a goal of sleeping at least 4 hours per night for 70% of the last 30 nights. Therefore the goal is 21 “good nights” of use. By tapping this section, you will see a screen that tracks your progress. An indication of reaching your goal will be displayed through a pop-up screen congratulating you. Additionally, a display of “Complete” will appear on the Last Session screen.
AHI	If enabled by your provider, this feature displays the nightly Apnea/Hypopnea index (AHI) value for the most recent one day time frame.
Mask fit	This screen displays how your mask fit during the most recent one day time frame. A display of “Good fit” indicates that the leak found allows for optimal performance of the device. A display of “Adjust fit” indicates that the leak may affect device performance, however, the device will remain functional and deliver therapy. If “Adjust fit” displays, adjust your mask to reduce the leak before starting therapy again. By tapping on “Adjust fit” or “Good fit”, you can choose to initiate a mask fit check. To run a mask fit check, put on your mask assembly and tap “Start” to begin a mask fit check.

## **Navigating the settings screens**

To adjust a setting:

1. Tap “Settings” from the Last Session screen.
2. Swipe up or down on the screen until you find the setting you want to adjust. The settings that can be changed appear in blue.

Note: If you see a series of dots on a setting, it indicates that there is more than one screen for that setting.





3. Tap the setting you want to view or change.
4. Tap the screen to change or select the setting. The display returns to the previous menu screen and the setting is saved.

Note: If you do not change a setting, tap “Back” on the top-left of the screen to exit back to the Last Session screen.

## Settings screens

When you tap “Settings”, you will be able to view the following Comfort and Device settings. These screens will only display if they are available and enabled on your device through your provider. Tap “Back” to exit to the Last Session screen.

### Comfort settings

Symbol	Meaning	Description
	RAMP PLUS (Ramp+)	RAMP PLUS allows you to adjust your starting pressure and time for added comfort when you are trying to fall asleep. In this setting you can set the time to 15, 30, or 45 minutes. You can also set the pressure to Off or from 4 cmH <sub>2</sub> O to 10 cmH <sub>2</sub> O in 1 cmH <sub>2</sub> O increments. During the set time, the air pressure will remain at your set starting pressure unless the device detects an event and identifies the need to increase your pressure. When RAMP PLUS has concluded, your prescribed therapy pressure will resume. Note: RAMP PLUS pressure can also be adjusted on the display screen during therapy.
	Humidity	You can change the humidification level setting from 0 to 5. This symbol only displays when humidification is enabled.
	Heated tube temperature	You can change this setting from 0 to 5. This symbol only displays when optional heated tube is connected.
	FLEX	This allows you to adjust the level of air pressure relief that you feel when you exhale during therapy. Your home care provider can enable or disable this feature. When your provider enables Flex, a level will already be set for you on the device. You change the setting between Off, 1, 2, and 3. The setting of “1” provides a small amount of pressure relief, with “2” and “3” providing additional relief.

## Device settings

Text	Description
Airplane Mode	This setting allows you to turn airplane mode on and off. Note: Airplane mode will automatically turn off after three days.
Bluetooth	This setting allows you to view or delete the Bluetooth connections on your device.
Time	This setting allows you to choose the time to display in a 12-hour or 24-hour format and set the current time.
Language	This setting allows you to choose which language to display on the UI.
Serial	Displays the serial number of the device.
Software	Displays the software version of the device.
Modem call	Displays the date of the last modem call and a status code. See the Modem Call section later in this manual for a description of the codes.
View reports	If enabled by your provider, tapping “View Reports” will allow you to view the past 1, 7, 30, 90, 180, or 365 days of therapy data. The remaining items in this table are accessed through “View Reports”.
Report range	Select the desired time period for the report (1, 7, 30, 90, 180, or 365 days).
Days used	The number of days the device was used since the start of therapy or during the selected period.
Days 4hrs+	The number of days the device was used for 4 hours or more since the start of therapy or during the selected period.
Avg Usage	The average amount of time the device was used since the start of therapy or during the selected period
Total Usage	The total number of hours the device was used during the selected period.

<b>Text</b>	<b>Description</b>
Avg Mask Fit	The average percentage of time there was a Good Mask Fit during the selected period.
Avg AHI	The average AHI for the days the device was used during the selected period.
90% Pressure	The average 90% pressure for the days the device was used during the selected period.

### **Modem call**

The modem will automatically make a call and upload therapy data at predetermined times set by your provider.

If a connection or upload attempt is successful or fails, a message will be displayed on the device settings Modem call screen indicating the status number. The status numbers are explained in the following table.

If an error code is displayed, contact your home care provider. They should check the Philips Respironics proprietary compliance software for additional information.

<b>Number</b>	<b>Description</b>
0-0	
0-1	Connection is in progress.
0-2	
0-3	Connection was made and call was successfully completed.
0-4	Connection is in progress.
1-0	
1-1	Connection error
1-2	
1-3	
1-4	Try removing power from the therapy device, wait 10 seconds, then plug the cord in again. If problem persists, contact your home care provider.
1-5	

<b>Number</b>	<b>Description</b>
2-0 2-1 2-2 2-3 2-4 2-5	Internal communication error
3-0 3-1 3-2	Software configuration error If problem persists, contact your home care provider. The provider should check the Philips Respironics proprietary compliance software for additional information.
4-0 4-1 4-2 4-3	Invalid Device Configuration Error Modem Service Required

## 4. Pop-up messages and troubleshooting

### Pop-up messages

Device pop-up messages may appear on your screen to alert you of a required action, device status update, or reminder. When the pop-up message appears, follow any required actions. See table below or the “Troubleshooting” section later in this manual for additional solutions to problems you may be experiencing. Tap “Dismiss” to close the pop-up message.

If you are unable to resolve the problem, contact your home care provider or Philips.

Message type	Message	Possible cause/additional action
Alert	Blocked air inlet Remove any obstructions from the inlet or filter. Clean or replace filter as needed.	Blockage at device inlet
Alert	Low leak Ensure mask and tube are connected properly without any obstruction.	Blockage at tube or mask Check tube is not crushed or folded such that air flow is restricted.
Alert	Contact support There may be a problem with your heated tube. Therapy will run without heating the tube.	Heated tube may be overheated or damaged. Turn off device. Detach heated tube from humidifier, make sure that tube is not covered or obstructed, and then reattach to humidifier. If alert continues, contact your provider.
Alert	Contact Support There may be a problem with your humidifier. Therapy will run without humidification.	Turn off device and disconnect from power. Visually check that electrical contacts are clear, then reconnect power cord. If alert continues, contact your provider.

<b>Message type</b>	<b>Message</b>	<b>Possible cause/additional action</b>
Alert	SD Card There was a problem reading your SD card. Please remove and reinsert.	Device cannot read the SD card. A problem may exist with the SD card, it was removed during a writing activity, or it was inserted incorrectly. Remove and reinsert the SD card. If alert continues, contact your provider.
Alert	SD Card Your SD card is full. Please refer to manual or contact your provider.	Remove SD card and replace with a new card, or contact your provider for a new SD card.
Safe State	Service Required Please contact support. (therapy button ring blinks continuously)	Indicates an error which enters device into “Safe State.” This allows power to remain on but airflow is disabled. Disconnect device from power. Reattach power cord to restore power. If the alert continues to occur, contact your home care provider.
Notification	Notification The attached power supply is operating from a battery and does not support humidification.	Disconnect the battery pack and use a compatible power supply or use the device without humidification.
Check Power (light blinks continuously)	Indicates an incompatible power supply is attached.	Switch to a Philips-provided power supply that is capable of supporting therapy. An 80W power supply is required to support humidification.
Low Voltage (light blinks continuously)	Low voltage	Confirm a compatible Philips Respironics power supply is attached. Switch to compatible power supply if needed. If battery is being used, ensure battery is adequately charged.
Notification	SD Card Your SD card has been removed. Please reinsert to record therapy data.	Indicates SD card has been removed from therapy device and not reinserted before the start of the current therapy session. Reinsert the SD card to record therapy data.

<b>Message type</b>	<b>Message</b>	<b>Possible cause/additional action</b>
Notification	Notification Your Auto Trial period has concluded. Therapy pressure has been updated.	No additional action required.
Notification	Device Update A new software version is available. Update now?	Tap “Update” to begin the software upgrade. Or Tap “Cancel” to cancel the update.
Notification	Notification You will begin the next level of EZ Start Pressure.	Displays when EZ-Start mode is enabled and device is increasing therapy pressure setting for the next session.

### **Status pop-up messages**

Following the pop-up message required actions or tap “Dismiss” to clear the message.

<b>Screen Text</b>	<b>Description</b>
Bluetooth	See the “Connectivity” section later in this manual for Bluetooth information.
SD Card Activity Do not remove SD card.	SD card read/write underway.
Update Your prescription has been updated.	A prescription update was successful.
Update A prescription or setting update was unsuccessful.	A prescription or setting update was unsuccessful. Contact your home care provider.
SD Removed Reinsert	Indicates SD card has been removed from therapy device and not reinserted before the start of the current therapy session. Reinsert the SD card to record therapy data.

Screen Text	Description
Auto Off Your device has automatically turned off due to inactivity.	This message appears when therapy ends due to automatic off function.
Pulse Oximetry Your pulse oximetry recording was successful.	You have achieved at least 4 hours of therapy and oximetry use.
Pulse Oximetry Minimum therapy hours not met. Your pulse oximetry recording was unsuccessful.	Minimum therapy hours not met. Your pulse oximetry recording was unsuccessful.

### Reminder pop-up messages

Reminder messages are messages from your home care provider reminding you of routine actions, such as changing the device filters, mask replacement, or upcoming appointments. The pop-up will automatically time out or you can click “Dismiss” to clear the message. If you have questions about any of the reminder pop-ups, contact your home care provider.

## Troubleshooting

Problem	Why it happened	What to do
Nothing happens when you apply power to the device.	There's no power at the outlet or the device is unplugged.	<p>If you are using AC power, check the outlet and verify that the device is properly plugged in. Make sure there is power available at the outlet. Make sure the AC power cord is connected correctly to the power supply and the power supply cord is securely connected to the device's power inlet. If the problem continues to occur, contact your home care provider. Return both the device and power supply to your provider, so they can determine if the problem is with the device or power supply.</p> <p>If you are using DC power, make sure your DC power cord and battery adapter cable connections are secure. Check your battery. It may need recharged or replaced. If the problem persists, check the DC cord's fuse following the instructions supplied with your DC cord. The fuse may need to be replaced. If the problem still occurs, contact your home care provider.</p>
The airflow does not turn on.	There may be a problem with the blower.	<p>Make sure the device is powered correctly. Press the Therapy button on top of the device to start airflow.</p> <p>If the airflow does not turn on, there may be a problem with your device. Contact your home care provider for assistance.</p>
The device's display is erratic.	The device has been dropped or mishandled, or the device is in an area with high Electromagnetic Interference (EMI) emissions.	<p>Unplug the device. Reapply power to the device. If the problem continues, relocate the device to an area with lower EMI emissions (away from electronic equipment such as cellular phones, cordless phones, computers, TVs, electronic games, hair dryers, etc.). If the problem still occurs, contact your home care provider for assistance.</p>

Problem	Why it happened	What to do
The airflow is much warmer than usual.	The air filters may be dirty. The device may be operating in direct sunlight or near a heater.	Rinse or replace the reusable air filter or replace the disposable ultra-fine filter. The temperature of the air may vary somewhat based on your room temperature. Make sure that the device is properly ventilated. Keep the device away from bedding or curtains that could block the flow of air around the device. Make sure the device is away from direct sunlight and heating equipment. If the problem continues, contact your home care provider.
The water in the humidifier water tank runs out before morning.	Humidifier water tank was not full at start of session. Mask leak is excessively high. The ambient conditions are very dry/cool.	Under most conditions, a full humidifier water tank should last for a typical sleep session if the humidifier tank is filled to the maximum fill line at the beginning of the sleep session. However, many factors impact water consumption, including: your humidifier or heated tube settings, the level of mask leak, and the duration of your sleep session. Make sure that the humidifier water tank is filled to the maximum fill line at the start of your sleep session. Check that your mask is fitted properly, and adjust as needed to reduce mask leak to normal levels.
I hear a leak or whistling sound coming from my therapy device (not related to mask leak).	The therapy device air inlet may be obstructed. The tube is not fully connected. The humidifier seals are not fully seated or are missing.	Check therapy device air inlet is not obstructed, and filters are free of debris and properly inserted. Confirm that the device, humidifier water tank, and tube are connected properly and not leaking. Confirm that the water tank lid seal is present and properly seated.

## 5. Connectivity

QoS: Wireless Quality of Service (QoS) refers to the necessary level of service and performance needed for the wireless functions of the device. It involves parameters such as reliability of data transmission, effective transfer rate, error rate, and mechanisms to define priority levels for time-critical signals.

Bluetooth® QoS: Bluetooth uses frequency hopping, channel coding, and error correction to address interference and is designed to operate with other devices that occupy the same spectrum. In addition to the measures defined in the Bluetooth standard, the DreamStation 2 radio incorporates other methods to minimize likelihood of QoS problems. These include:

- Data sent between the CPAP and any external devices use an additional checksum verification to ensure that data is correctly received without errors.
- For all Bluetooth applications except pulse oximeter: The CPAP is a portable device and will not always be near the mobile device when the CPAP is ready to transfer data. The mobile device attempts to reconnect until it successfully connects and the data transfer is complete.
- For use with pulse oximeter: The radio receives pulse rate and O<sub>2</sub> level once per second and stores that data along with the time stamp. The data from the pulse oximeter is checked for validity and thrown away if not valid. This data is not displayed locally but is logged, and after a minimum of 4 hours of data is collected it is sent to the remote server. If the CPAP is not able to get 4 hours of good data it alerts the patient, and the patient will need to use it again the next night. The data is not used to diagnose the patient's condition, and will continue to reconnect to the pulse oximeter until a connection is achieved.

### Cellular QoS

The Cellular modem is designed for use with select Philips Respironics therapy devices. It automatically transfers data between the DreamStation 2 device and Philips Respironics proprietary compliance software. The DreamStation 2 modem incorporates various methods to minimize likelihood of QoS problems. These include:

- No real time data monitoring is used in this application. If the data transfer is unsuccessful, the modem attempts to reconnect until it successfully connects and the data transfer is complete.
- Data sent between the CPAP and any external devices uses an additional checksum verification to ensure that data is correctly received without errors.

For information on Bluetooth use and pairing, see the “Bluetooth wireless technology” and “Pairing your therapy device to your Bluetooth-enabled mobile device” sections of this manual.

## 6. Accessories

There are several optional accessories available for your DreamStation 2 Advanced device. For a full list of accessories that can be used with this device, see the DreamStation 2 accessory list at [www.philips.com/IFU](http://www.philips.com/IFU). Contact your home care service provider for additional information on the available accessories. When using optional accessories, always follow the instructions enclosed with the accessories.

### SD card

The device may come with an SD card inserted in the SD card slot behind the water tank. The SD card stores information for the home care provider. Your home care provider may ask you to periodically remove the SD card and send it to them for evaluation.

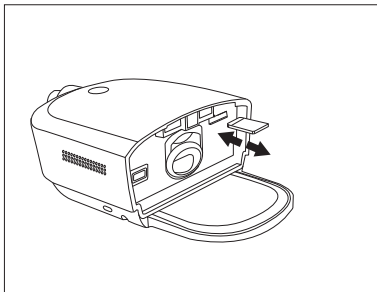

### Updating software using an SD card

You can update the device software using an SD card. The software update must be done when the therapy is off.

1. Connect the device to power.
2. Insert an SD card with the new software version into the device. After approximately 15 to 20 seconds, a pop-up screen appears displaying:

A new software version is  
available. Update now?

Update  
Cancel

3. Tap Update to continue with the software upgrade. To cancel the software upgrade, tap Cancel.
4. When the update begins, the screen displays “Software Update Active” and the therapy button ring flashes. The screen will then appear black or may display a progress bar until the update is complete.
5. The device will restart when the upgrade is complete. Remove the SD card.
6. If an error occurs, contact Philips Respironics for a new SD card.

## **Oximeter**

The DreamStation 2 Advanced device can pair to a Nonin BT Pulse Oximeter, using Bluetooth, for measuring %SpO<sub>2</sub> and pulse rate.

To use a pulse oximeter with your therapy device, follow these steps.

1. Follow the setup instructions provided with your pulse oximeter and finger sensor.
2. Attach the finger sensor to your forefinger.
3. Press the Therapy button on your device to begin therapy.
4. Once the device detects a good connection with the pulse oximeter, both the Bluetooth symbol and “SpO<sub>2</sub>” will display on the top of the display screen.

Note: It may take up to 30 seconds for the device to recognize the pulse oximeter.

When you have achieved at least 4 hours of therapy and oximetry use, a pop-up will appear stating the pulse oximetry reading was successful. If you do not reach the minimum therapy hours, a pop-up appears stating that the pulse oximetry reading was unsuccessful.

## **Roll stand**

There is a roll stand available for use with your DreamStation 2 device. Please see the instructions included with your roll stand for more information.

## Supplemental oxygen

Oxygen can be added to the patient circuit. Please note the warnings listed below when using oxygen with the device.

### Warnings

- **When using oxygen with this system, the oxygen supply must comply with local regulations for medical oxygen.**
- **Oxygen supports combustion. Oxygen should not be used while smoking or in the presence of an open flame.**
- Do not use the device in the presence of a flammable anaesthetic mixture in combination with oxygen or air, or in the presence of nitrous oxide..
- If supplemental oxygen is added at the exit of the flow generator or humidifier, a Philips Respironics Pressure Valve must be placed in-line with the patient circuit between the device and the oxygen source. The pressure valve helps prevent the backflow of oxygen from the patient circuit into the device when the unit is off. Failure to use the pressure valve could result in a fire hazard.
- **When using oxygen with this system, turn the device on before turning on the oxygen. Turn the oxygen off before turning the device off. This will prevent oxygen accumulation in the device.**
- **Do not connect the device to an unregulated or high pressure oxygen source.**

## DC power

A Philips Respironics DC power cord can be used to operate this device in a stationary recreational vehicle, boat, or motor home. In addition, a Philips Respironics DC battery adapter cable, when used with a DC power cord, allows the device to be operated from a 12 VDC free-standing battery.

**Warning: Periodically inspect electrical cords and cables for damage or signs of wear. Discontinue use and replace if damaged.**

### Cautions

- Always ensure that the DC power cord securely fits into your therapy device prior to use. Contact your home care provider or Philips Respironics to determine if you have the appropriate DC cord for your specific therapy device.
- When DC power is obtained from a vehicle battery, the device should not be used while the vehicle's engine is running. Damage to the device may occur.
- Only use a Philips Respironics DC Power Cord and Battery Adapter Cable. Use of any other system may cause damage to the device.

Refer to the instructions supplied with the DC power cord and adapter cable for information on how to operate the device using DC power.

## Carrying case and airline travel

When traveling, the carrying case is for carry-on luggage only. The carrying case will not protect the system if it is put through checked baggage. Do not travel with water in the water tank.

The device is suitable for use on airlines when the device is operating from an AC or DC power source.

For your convenience at security stations, there is a symbol on the bottom of the device indicating that it is medical equipment and is suitable for airline use. It may be helpful to bring this manual along with you to help security personnel understand the device.

If you are traveling to a country with a line voltage different than the one you are currently using, a different power cord or an international plug adaptor may be required to make your power cord compatible with the power outlets of the country to which you are traveling. Contact your home care provider for additional information.

## 7. Cleaning and care

**Warning:** Allow the humidifier heater plate and water to cool down for approximately 15 minutes before removing the water tank. A burn may result from: touching the heater plate, coming in contact with the heated water, or touching the tank base.

### **Home cleaning: device exterior, heater plate, and humidifier air inlet seal**

Clean the device exterior surface weekly.

1. To avoid electrical shock, make sure that the device is disconnected from all outlets and power sources. Remove any cables attached to the device or battery pack.
2. Remove the humidifier tank from the device.
3. Use a lint-free cloth dampened (not dripping) with a liquid soap solution (1 teaspoon of liquid dish soap per gallon of warm water) to clean the exterior of the device, heater plate, and humidifier air inlet seal.
4. Work the cloth into the areas around the therapy button, humidifier air inlet/outlet seal, and any other areas where soil may be difficult to remove. Ensure that you remove all visible soil.
5. Use a lint-free cloth dampened (not dripping) with clean water to remove all detergent residue.
6. Inspect the device for cleanliness. If necessary, repeat the cleaning steps until all surfaces are visibly clean.
7. Allow the device to dry completely before reconnecting it to a power source.
8. Inspect the device and all circuit parts (filter, tube, and mask) for damage, such as cracks, tears, or broken pieces. Replace any damaged parts.

### **Home cleaning: humidifier water tank (lid, water tank base, and water tank seal)**

Clean the humidifier water tank before first use. Hand wash daily. The humidifier water tank can also be washed in the dishwasher weekly.

1. Press the therapy button to stop the airflow, and allow the heater plate and water to cool.
2. Remove the water tank from the device and remove the lid and water tank seal from the tank base.

3. Wash the humidifier water tank (lid, water tank base, and water tank seal) in the dishwasher (top shelf only) or in a solution of warm potable water and a mild liquid dishwashing detergent (1 teaspoon of liquid dish soap per gallon of warm water) using a soft bristle brush to remove adhering substances.

**Note:** Pay close attention to all corners and crevices.

4. Fully immerse and rinse each item separately with potable water for one minute and agitate vigorously.
5. Allow all parts to air dry.
6. Inspect the humidifier water tank for damage. If any parts show signs of wear or damage, contact your home care provider for a replacement.
7. Re-install the water tank seal. To install, insert the seal into the back of the tank base and then press the seal down until it is fully seated into the water tank base.

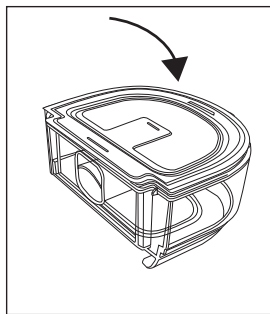
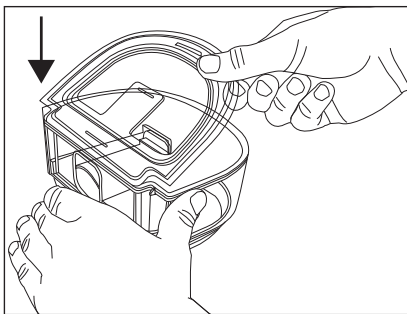

8. Before reinstalling the humidifier water tank, fill it with distilled water no higher than the maximum fill line.

## Home cleaning: tubing

Hand wash the tubing, mask adapter (if included), and connectors (if included) before first use and weekly. Discard and replace the tubing every 6 months.

1. Disconnect the flexible tubing from the device.
2. Gently wash the tubing, including any adapters or connectors, in a solution of warm water and a mild liquid dish soap solution to adequately remove adhering substances from the tube, adapters, and connectors. Be sure to clean the entire inner surface of the tube by ensuring it is fully immersed in the detergent solution during gentle agitation by hand.
3. Rinse thoroughly to remove all soap residue from the tube, adapters, and connectors with water and allow to air dry. Make sure all parts are dry before next use.
4. Visually inspect the tubing for cleanliness. Repeat the cleaning if not visually clean.
5. Inspect the tubing for damage or wear (cracking, tears, punctures, etc.). Discard and replace if necessary.

## Caring for the filters

### Notes

- Only Philips supplied filters should be used as replacement filters.
- Replace the blue disposable, ultra-fine filter if it is damaged or has accumulated debris.

Under normal usage, you should rinse the grey reusable filter at least once every two weeks and replace it with a new one every six months.

The disposable, ultra-fine filter should be replaced after 30 nights of use, or sooner, if it appears clogged. DO NOT rinse the ultra-fine filter.

1. If the device is operating, press the Therapy button to stop the airflow. Unplug the power cord from the wall outlet.
2. Remove the water tank to access the filter area, then remove the filter from the device. Refer to the “Install/replace the air filters” section earlier in this manual.
3. Take the reusable filter to a sink and run warm tap water through the white middle portion of the filter to rinse away any debris.
4. Shake the filter to remove as much water as possible.
5. Allow the filter to air dry completely before reinstalling it. If the filter is damaged, replace it.
6. Reinstall the filter into the filter access area on the device.

## Service

The device does not require routine servicing.

**Warning:** If you notice any unexplained changes in the performance of this device, if it is making unusual or harsh sounds, if it has been dropped or mishandled, if water is spilled into the enclosure, or if the enclosure is broken, disconnect the power cord and discontinue use. Contact your home care provider.

## 8. Technical specifications

### Environmental

Operating Temperature	Device: 5° to 35°C (41° to 95°F)
Storage Temperature	-20° to 60°C (-4° to 140°F)
Relative Humidity (operating & storage)	15 to 95% (non-condensing)
Atmospheric Pressure:	Device: 101 to 77 kPa (0 - 2286 m / 0 - 7500 ft)

### Physical

Dimensions	273.81 mm L x 158.5 mm W x 84.83 mm H (10.78 in L x 6.24 in W x 3.34 in H)
Weight (empty water tank without power supply)	1040 g (2.29 lbs)

### Service life

The expected service life of the DreamStation 2 Advanced device is five (5) years.

The expected service life of the DreamStation 2 Advanced humidifier water tank is one (1) year.

The expected service life of the DreamStation 2 humidifier air inlet/outlet seal is one (1) year.

## Standards compliance

This device is designed to conform to the following standards:

- IEC 60601-1 General Requirements for Basic Safety and Essential Performance of Medical Electrical Equipment
- IEC 60601-1-11 General Requirements for Basic Safety and Essential Performance in the Home Healthcare Environment
- IEC 60601-1-6 General Requirements for Safety - Usability
- IEC 62366 Application of Usability Engineering in Medical Devices
- IEC 62304 Medical Device Software – Software Life-cycle Processes
- ISO 80601-2-70 Sleep Apnea Breathing Therapy Equipment
- ISO 80601-2-74 Respiratory Humidifying Equipment
- EN 60601-1-2 Electromagnetic Compatibility

## IEC 60601-1 classification

Type of Protection Against Electric Shock	Class II Equipment
Degree of Protection Against Electric Shock	Type BF Applied Part
Degree of Protection Against Ingress of Water	Device: Drip Proof, IP22 First characteristic numeral - 2 - Protection against ingress of solid foreign objects $\geq 12.5$ mm diameter. Explanation: Protected against access to hazardous parts with a finger and protected against solid foreign objects of 12.5 mm diameter and greater. Second characteristic numeral - 2 - Protection against ingress of water with harmful effects dripping (15° tilted). Explanation: Protected against vertically falling water drops when enclosure tilted up to 15°.
Mode of Operation	Continuous
Electrical	AC Power Consumption: 100–240 VAC, 50/60 Hz, 2.0-1.0 A
Water capacity	325 ml (11 oz.) at recommended water level

Heater plate	Max Temperature: 68°C (154°F)
Humidity	Humidity <sub>min</sub> Output: ≥ 12 mg H <sub>2</sub> O/L Measured at expected leak across therapy pressures , 17 °C– 35°C, 15% RH for all compatible tubes.
Maximum delivered gas temperature	<43°C (109.4°F)

### Declared dual-number noise emissions values (in accordance with ISO 4871)

Tube Size	Sound Pressure Level	Uncertainty	Sound Power Level	Uncertainty
15 and 22 (mm) tubing type	27 dB(A)	2 dB(A)	35 dB(A)	2 dB(A)
12 (mm) tubing type	27 dB(A)	2 dB(A)	35 dB(A)	2 dB(A)

### Pressure accuracy

Pressure Increments: 4–20 cmH<sub>2</sub>O (in 0.5 cmH<sub>2</sub>O increments)

Maximum static and dynamic pressure accuracy, according to ISO 80601-2-70:2015:

Tube Type	Static	Dynamic 4 to 20 cmH <sub>2</sub> O
15 and 22 (mm) tubing type	± 0.5 cmH <sub>2</sub> O	± 1.0 cmH <sub>2</sub> O
12 (mm) tubing type	± 1.0 cmH <sub>2</sub> O	± 2.0 cmH <sub>2</sub> O

Static pressure accuracy has a measurement uncertainty of 1.31%.

Dynamic pressure accuracy has a measurement uncertainty of 2.70%.

## Maximum flow rate (typical)

Tube Type	Flow	Test pressures (cmH <sub>2</sub> O)				
		4	8	12	16	20
12 (mm) tubing type (heated or non-heated)	Average flow at the patient connection port (l/min)	120	117	108	101	92
15 (mm) tubing type (heated or non-heated)	Average flow at the patient connection port (l/min)	121	135	125	116	107
22 (mm) tubing type	Average flow at the patient connection port (l/min)	122	141	131	122	112

## ISO 80601-2-70 Pneumatic Diagram

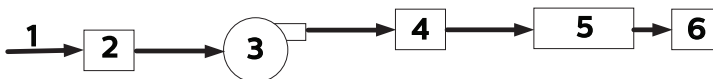

#	Feature
1	Air
2	Filter & air inlet
3	Blower
4	Air outlet
5	6 ft. tubing
6	Mask

## Wireless notices

- The Bluetooth® word mark and logos are registered trademarks owned by Bluetooth SIG, Inc. and any use of such marks by Philips Respironics is under license. Other trademarks and trade names are those of their respective owners.
- The DreamStation 2 device is capable of transmitting data between the therapy device and a mobile device. This connection between the therapy device and a mobile device is encrypted.
- A small portion of the firmware that performs data encryption on the DreamStation 2 device is being utilized under the Apache 2.0 and Mozilla 2.0 licenses. These licenses are available at:  
[www.apache.org/licenses/LICENSE-2.0](http://www.apache.org/licenses/LICENSE-2.0) and <https://www.mozilla.org/en-US/MPL/2.0/>
- This product meets RF exposure requirements when it is positioned with a separation distance of at least 20 cm away from the body.
- This device is a certified Bluetooth radio device with: FCC ID (USA): THO1141623
- Use of non-original manufacturer-approved accessories may violate your local RF exposure guidelines and should be avoided.
- This device complies with part 15 of the FCC Rules. Operation is subject to the following two conditions: (1) This device may not cause harmful interference, and (2) this device must accept any interference received, including interference that may cause undesired operation. This equipment has been tested and found to comply with the limits for a Class B digital device, pursuant to Part 15 of the FCC Rules. These limits are designed to provide reasonable protection against harmful interference in a residential installation. This equipment generates, uses, and can radiate radio frequency energy and, if not installed and used in accordance with the instructions, may cause harmful interference to radio communications. However, there is no guarantee that interference will not occur in a particular installation. If this equipment does cause harmful interference to radio, TV reception, or other devices which can be determined by turning the equipment on and off, the user is encouraged to try to correct the interference by one or more of the following measures:
  - Reorient or relocate the receiving antenna (on the radio, TV, or other device).
  - Increase the separation between the equipment and receiver.
  - Connect the equipment into an outlet on a circuit different from that to which the receiver is connected.
  - Consult the dealer of the device for help.

## Radio Specifications

### Cellular

Operating Frequency Range	Band 2: 1850 – 1910 MHz Transmit 1930 – 1990 MHz Receive Band 4: 1710 – 1755 MHz Transmit 2110 – 2155 MHz Receive Band 5: 824 – 849 MHz Transmit 869 – 894 MHz Receive Band 12: 699 – 716 MHz Transmit 729 – 746 MHz Receive Band 13: 746 – 756 MHz Receive 777 – 787 MHz Transmit
Maximum Output Power	25 dBm
Modulation	OFDM/SC-FDMA
Bandwidth:	1.4 MHz

### Bluetooth

Operating Frequency Range	2.4-2.4835 GHz
Maximum Output Power	0 dBm
Modulation	GFSK
Bandwidth:	1 MHz

## Intake Port Filters

Pollen Filter	100% Polyester 88% Efficient @ 7-10 micron size
Ultra-fine Filter	Blended Synthetic Fiber 95% Efficient @ 0.5-0.7 micron size

## Heated Tubing Specifications

Maximum Recommended Pressure	20 cmH <sub>2</sub> O
Inner Diameter	15 mm (HT15) 12 mm (HT12)
Length	1.83 m (6 ft.)
Heated Tubing Temperature Range	16° to 30° C (60° to 86° F)
Heated Tubing Temperature Cut-out	≤ 41° C (≤ 106° F)
Material	Flexible plastic and electrical components

## Disposal

Dispose of this device in accordance with local regulations.

## 9. EMC information

Your unit has been designed to meet EMC standards throughout its Service Life without additional maintenance. There is always an opportunity to relocate your DreamStation 2 Advanced Therapy Device within an environment that contains other devices with their own unknown EMC behavior. If you believe your unit is affected by locating it closer to another device, simply separate the devices to remove the condition.

## Pressure and Flow Accuracy

If you suspect that the pressure and/or flow rate accuracy is affected by EMC interference remove power and relocate the device to another area. If performance continues to be affected discontinue use and contact your home care provider.

## SpO<sub>2</sub> and Pulse Rate Accuracy

The DreamStation 2 therapy device is designed to capture the SpO<sub>2</sub> and pulse rate oximetry data within the accuracy specification described in the sensor manufacturer's instructions for use. When 4 hours of successful oximetry data have been achieved the device indicates this to the user by displaying "Your pulse oximetry recording was successful". If you suspect that your unit is affected by EMC interference, remove power and relocate the device to another area. If performance continues to be affected discontinue use and contact your home care provider.

Guidance and Manufacturer's Declaration - Electromagnetic Emissions – This device is intended for use in the electromagnetic environment specified below. The user of this device should make sure it is used in such an environment.

EMISSIONS TEST	COMPLIANCE	ELECTROMAGNETIC ENVIRONMENT - GUIDANCE
RF emissions CISPR 11	Group 1	The device uses RF energy only for its internal function. Therefore, its RF emissions are very low and are not likely to cause any interference in nearby electronic equipment.
RF emissions CISPR 11	Class B	The device is suitable for use in all establishments, including domestic establishments and those directly connected to the public low-voltage power supply network.
Harmonic emissions IEC 61000-3-2	Class A	
Voltage fluctuations/Flicker emissions IEC 61000-3-3	Complies	
Emission of Radio Frequency Energy RTCA/DO-160G Section 21	Category M	This device is suitable for use onboard commercial airplanes inside passenger cabin.

Guidance and Manufacturer's Declaration - Electromagnetic Immunity – This device is intended for use in the electromagnetic environment specified below. The user of this device should make sure it is used in such an environment.

IMMUNITY TEST	IEC 60601 TEST LEVEL	COMPLIANCE LEVEL	ELECTROMAGNETIC ENVIRONMENT - GUIDANCE
Electrostatic Discharge (ESD) IEC 61000-4-2	±8 kV contact  ±2 kV, ±4 kV, ±8 kV, & ±15 kV air discharges	±8 kV contact  ±2 kV, ±4 kV, ±8 kV, & ±15 kV air discharges	Floors should be wood, concrete or ceramic tile. If floors are covered with synthetic material, the relative humidity should be at least 35%.
Electrical fast Transient/ burst IEC 61000-4-4	±2 kV for power supply lines, 100 kHz repetition rate	±2 kV for power supply lines, 100 kHz repetition rate	Mains power quality should be that of a typical home or hospital environment.
	±1 kV for input-output lines; 100 kHz repetition rate	N/A- Device does not have user I/O lines that are longer than 3m in length.	
Surge IEC 61000-4-5	±1 kV differential mode  ±2 kV common mode	±1 kV differential mode  N/A: Device is Class 2 and does not have earth connection.	Mains power quality should be that of a typical home or hospital environment.

IMMUNITY TEST	IEC 60601 TEST LEVEL	COMPLIANCE LEVEL	ELECTROMAGNETIC ENVIRONMENT - GUIDANCE
Voltage dips, short interruptions and voltage variations on power supply input lines IEC 61000-4-11	<p>&lt;5% <math>U_T</math> (&gt;95% dip in <math>U_T</math>) for 0.5 cycle at 45 degree increments</p> <p>&lt;5% UT (&gt;95% dip in UT) for 1 cycle</p> <p>70% UT (30% dip in UT) for 0.5 seconds</p> <p>&lt;5% UT (&gt;95% dip in UT) for 5 seconds</p>	<p>&lt;5% <math>U_T</math> (&gt;95% dip in <math>U_T</math>) for 0.5 cycle at 45 degree increments</p> <p>&lt;5% UT (&gt;95% dip in UT) for 1 cycle</p> <p>70% UT (30% dip in UT) for 0.5 seconds</p> <p>&lt;5% UT (&gt;95% dip in UT) for 5 seconds</p>	Mains power quality should be that of a typical home or hospital environment. If the user of the device requires continued operation during power mains interruptions, it is recommended that the device be powered from an uninterruptible power supply or a battery.
Power frequency (50/60 Hz) magnetic field IEC 61000-4-8	30 A/m	30 A/m	Power frequency magnetic fields should be at levels characteristic of a typical location in a typical hospital or home environment.
NOTE: $U_T$ is the a.c. mains voltage prior to application of the test level.			

Guidance and Manufacturer's Declaration – Electromagnetic Immunity – This device is intended for use in the electromagnetic environment specified below. The user of this device should make sure it is used in such an environment.

IMMUNITY TEST	IEC 60601 TEST LEVEL	COMPLIANCE LEVEL	ELECTROMAGNETIC ENVIRONMENT - GUIDANCE
Conducted RF IEC 61000-4-6	3 Vrms 150 kHz to 80 MHz  6 Vrms Amateur Radio & ISM Bands between 150 kHz and 80 MHz	3 Vrms 150 kHz to 80 MHz  6 Vrms Amateur Radio & ISM Bands between 150 kHz and 80 MHz	Portable and mobile RF communications equipment should be used no closer to any part of the device, including cables, than the recommended 30 cm (12 inches) separation distance.
Radiated RF IEC 61000-4-3	10 V/m 80 MHz to 2.7 GHz  Telecommunication frequencies as specified in clause 8.10 of IEC 60601-1-2:2014:  450, 810, 870, 930, 1720, 1845, 1970, and 2450 MHz at 28 V/m  385 MHz at 27 V/m  710, 745, 780, 5240, 5500, and 5785 MHz at 9 V/m	10 V/m     28 V/m   27 V/m  9 V/m	Interference may occur in the vicinity of equipment marked with the following symbol: 

## Limited Warranty

Respironics, Inc., a Philips company (“Philips Respironics”) provides this non-transferable, limited warranty for DreamStation 2 (“Product”) to the customer who originally purchased the Product directly from Philips Respironics.

**What this Warranty Covers:** Philips Respironics warrants each new Product will be free from defects in materials and workmanship and will perform in accordance with the Product specifications under normal and proper use and maintenance in accordance with applicable instructions, subject to the exclusions below.

**How Long does this Warranty Last:** Two (2) years from the longer of the date of shipment to the purchaser or date of setup by purchaser for the end user, except:

The warranty period for accessories, replacement parts, and disposables including, but not limited to, tubing, filters, carrying case, and power cord is 90 days from the date of shipment to the original purchaser.

**What this Warranty does not cover:** This warranty does not apply to any software included with the Product as the software warranty is included in the software license. This warranty does not cover damage or injury whether to the Products, personal property, or persons caused by accident, misuse, abuse, Acts of God, water ingress, repair or alteration by anyone other than Philips Respironics or its authorized service center, failure to operate in accordance with the terms of the operating manual and instructions, lack of reasonable care, the discontinuance of a network (e.g. 2G, 3G, etc.) by a carrier (e.g. ATT, Verizon, etc.), or other defects not related to material or workmanship. This warranty is not transferable. If Philips Respironics finds that a Product returned for service or the issue raised is not covered under this limited warranty, Philips Respironics may charge an evaluation fee and return shipping.

**What Philips Respironics will do:** If a Product does not meet the warranty above in the first 90 days after the original shipment date, Philips Respironics will replace the device with a new Product. Thereafter, if a Product fails to conform to the warranties set forth above during the applicable warranty period, Philips Respironics will repair or replace the Product or refund the original purchase price, in Philips Respironics sole discretion. Philips Respironics may use new or remanufactured assemblies, components, and parts in repair and new or recertified refurbished devices for replacement. The balance of the original warranty period will apply to any Product or component of a Product repaired or replaced under this warranty.

**Warranty Disclaimer; Limitation of Liability:** EXCEPT AS SET FORTH IN THIS LIMITED WARRANTY, PHILIPS RESPIRONICS MAKES NO WARRANTIES, EXPRESSED OR IMPLIED, STATUTORY OR OTHERWISE, REGARDING THE PRODUCT OR ITS QUALITY OR PERFORMANCE. PHILIPS RESPIRONICS SPECIFICALLY DISCLAIMS THE IMPLIED WARRANTY OF MERCHANTABILITY AND THE IMPLIED WARRANTY OF FITNESS FOR A PARTICULAR PURPOSE. IN NO EVENT WILL PHILIPS RESPIRONICS MAXIMUM LIABILITY UNDER THESE WARRANTIES EXCEED THE ORIGINAL PURCHASE PRICE OR WILL PHILIPS RESPIRONICS BE LIABLE FOR ANY ECONOMIC LOSS, LOSS OF PROFITS, OVERHEAD, OR SPECIAL, INCIDENTAL, OR CONSEQUENTIAL DAMAGES. Repair, replacement, or return of purchase price by Philips Respiroics is the original purchaser's sole and exclusive remedy under this warranty. This warranty gives you specific legal rights, and you may also have other rights that vary from state to state. Some states do not allow the exclusion or limitation of incidental or consequential damages, so the above exclusion and limitations may not apply to you.

**How to get warranty support:** Patients contact your local authorized Philips Respiroics dealer and dealers contact Respiroics, Inc. at:

1001 Murry Ridge Lane  
Murrysville, Pennsylvania 15668-8550  
+1-724-387-4000



 Respironics Inc.  
1001 Murry Ridge Lane  
Murrysville, PA 15668 USA

**REF** 1143581



1143581 R02  
ZL 01/27/2021  
EN-DOM